

A

A

B

B

C

C

D

D

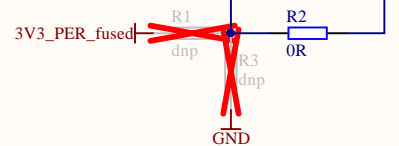
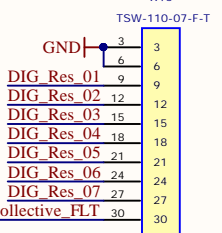
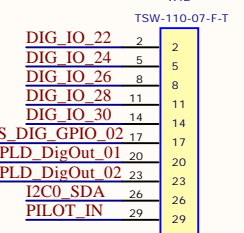
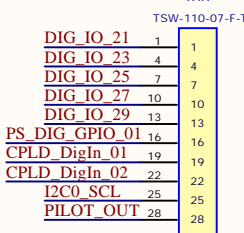
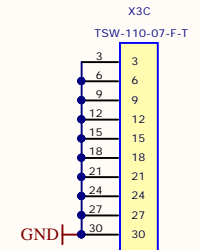
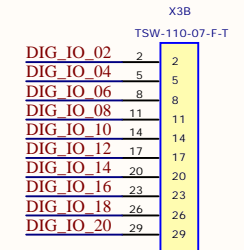
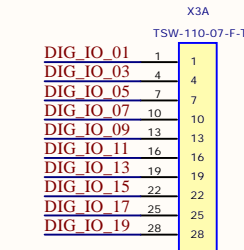
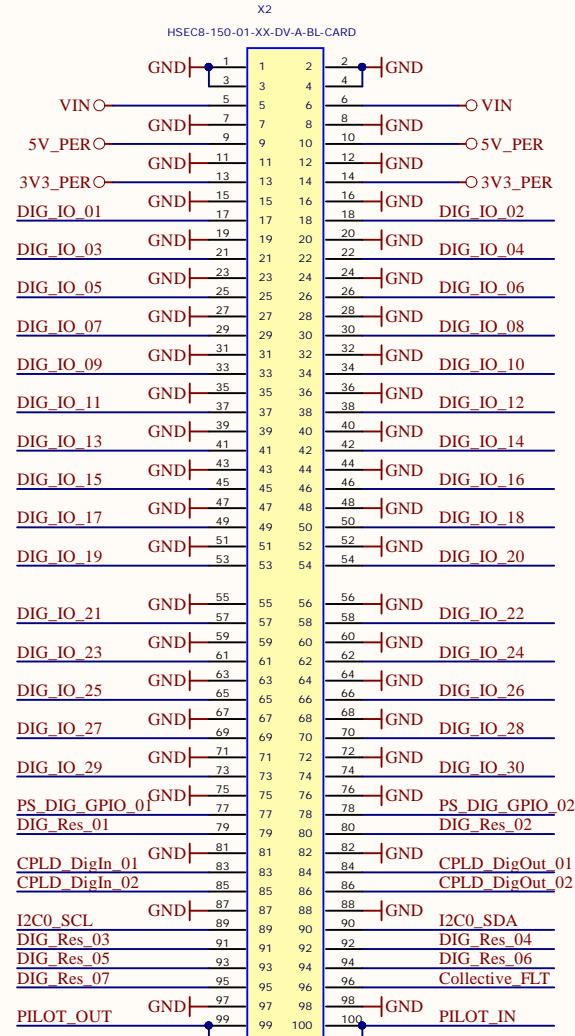
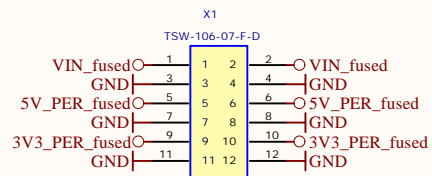
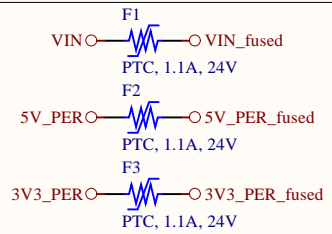

Title Connector.SchDoc		Technische Hochschule Nürnberg Georg Simon Ohm Wassertorstr. 10 90489 Nürnberg GERMANY		Cannot open file D:\Andreas_Geiger\0
Size: A4	Revision: 1v0			
Date: 07.08.2019	Time: 16:13:30	Sheet 1 of 2	Author: Andreas Geiger	
Project: UltraZohm_Digital_Incremental_Encoder.PrjPcb				

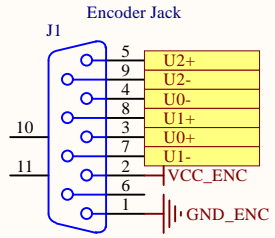
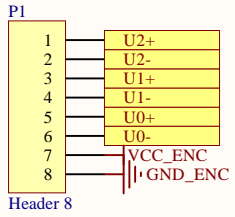

Label	Pin	Encoder	Color(Kübler)
U0+	Pin3	0+	blue
U0-	Pin4	0-	red
U1+	Pin8	A+	green
U1-	Pin7	A-	yellow
U2+	Pin5	B+	grey
U2-	Pin9	B-	pink
VCC_ENC	Pin2	UB	brown
GND_ENC	Pin1	0V	white
NC	Pin6	--	

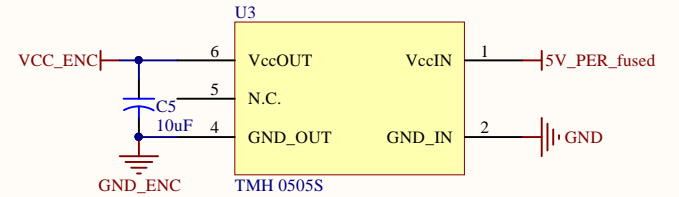
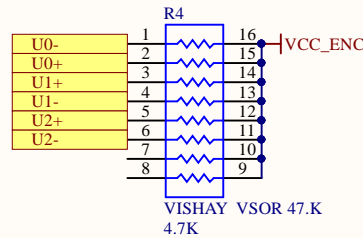
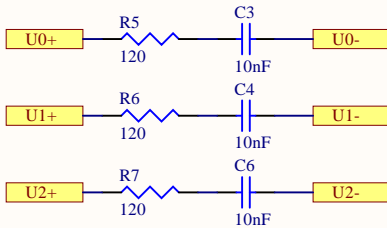
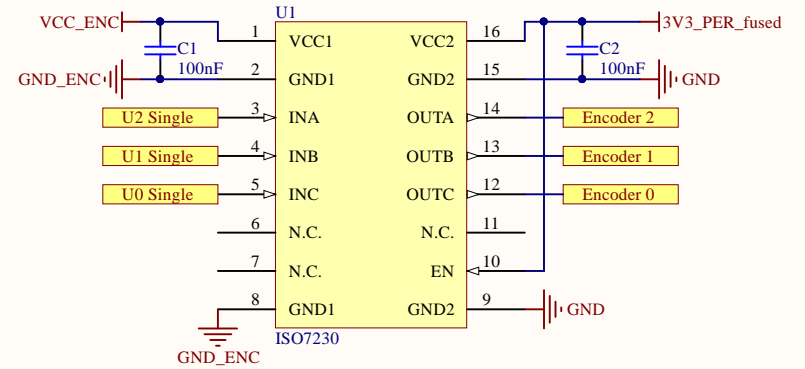
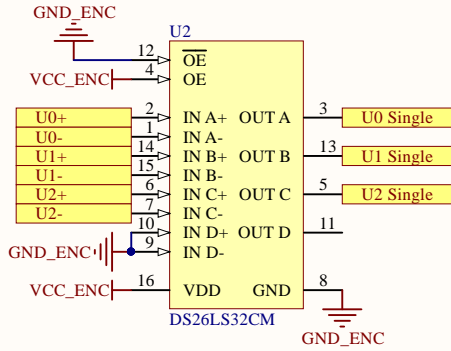

Title		
Size	Number	Revision
A4		
Date:	07.08.2019	Sheet of
File:	\\.\Encoder.SchDoc	Drawn By: